

HONDA

OWNER'S MANUAL

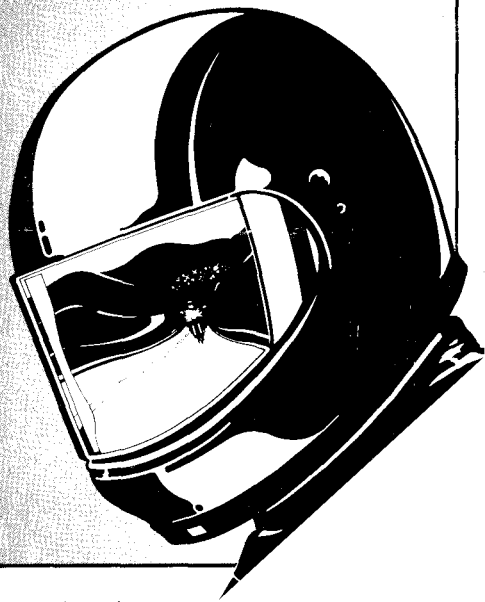

SE50

IMPORTANT NOTICE

- **OPERATOR ONLY. NO PASSENGER**

This motorcycle is designed and constructed as an operator-only model. The seating configuration does not safely permit the carrying of a passenger. Do not exceed the maximum weight capacity shown on the accessories and loading label.

- **ON-ROAD USE ONLY**

This motorcycle is designed to be used only on the road.

- **READ THIS OWNER'S MANUAL CAREFULLY**

Pay special attention to statements preceded by the following words:

⚠ WARNING

Indicates a strong possibility of severe personal injury or death if instructions are not followed.

CAUTION:

Indicates a possibility of personal injury or equipment damage if instructions are not followed.

NOTE: Gives helpful information.

This manual should be considered a permanent part of the motorcycle and should remain with the motorcycle when resold.

**HONDA ELITE
SE50/SE50M
OWNER'S MANUAL**

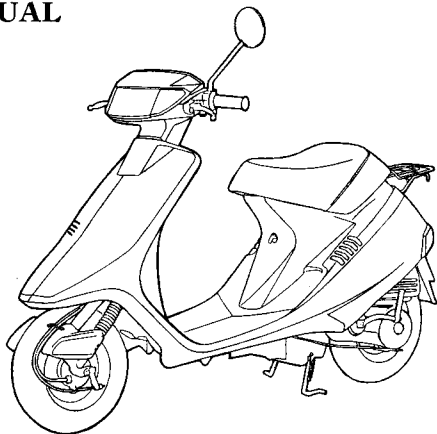

All information in this publication is based on the latest production information available at the time of approval for printing. HONDA MOTOR CO., LTD. reserves the right to make changes at any time without notice and without incurring any obligation.

No part of this publication may be reproduced without written permission.

© HONDA MOTOR CO., LTD. 1988

WELCOME

Thank you for purchasing this Honda motorcycle and welcome to the family of Honda motorcycle riders. To enjoy safer and more pleasant riding, become thoroughly familiar with this owner's manual **BEFORE YOU RIDE MOTORCYCLE**. Your safety depends not only on your own alertness and familiarity with the motorcycle, but also the motorcycle's mechanical condition. A pre-ride inspection before every outing and regular maintenance are essential.

When regular maintenance or repairs are required, remember that your authorized Honda dealer knows what it takes to keep your Honda going strong. If you have the required mechanical "know-how" and tools, your Honda dealer can supply you with an official Honda Service Manual to help you perform many maintenance and repair tasks.

Pleasant riding, and thank you for choosing a Honda.

- The illustrations herein are based on the DK type.
- Following codes in this manual indicate each country.

U	Australia
DK	Europe

- The specifications may vary with each locale.

OPERATION

Page		Page	
1	MOTORCYCLE SAFETY	24	Handlebar Controls
1	Safe Riding Rules	28	FEATURES (Not required for operation)
3	Protective Apparel	28	Steering Lock
4	Modifications	29	Helmet Holder
5	Loading and Accessories	30	Seat Lock
7	PARTS LOCATION	31	Document Bag
10	Instruments and Indicators	32	OPERATION
13	MAJOR COMPONENTS (Information you need to operate this motorcycle)	32	Pre-ride Inspection
13	Brakes	33	Starting the Engine
15	Fuel	37	Running-in
18	Engine Oil	38	Riding
20	Tyres	45	Parking
23	ESSENTIAL INDIVIDUAL COMPONENTS	46	Anti-theft Tips
23	Ignition Switch		

MAINTENANCE

Page

47 MAINTENANCE

48 Maintenance Schedule

50 Serial Numbers

51 Colour Label

51 Maintenance Precautions

52 Air Cleaner

54 Spark Plug

56 Idle Speed

57 Brake Shoe Wear

58 Battery

59 Fuse Replacement

Page

61 TRANSPORTING

62 CLEANING

64 STORAGE GUIDE

64 Storage

64 Removal from Storage

66 SPECIFICATIONS

69 NOISE CONTROL SYSTEM
(AUSTRALIA ONLY)

69 Tampering with noise control system
prohibited

MOTORCYCLE SAFETY

▲ WARNING

- * **Motorcycle riding requires special efforts on your part to ensure your safety. Know these requirements before you ride:**

SAFE RIDING RULES

1. Always make a pre-ride inspection (page 32) and perform any needed adjustments or repairs before you ride the motorcycle. You may prevent an accident or equipment damage.
2. This motorcycle has been designed and constructed as an *operator-only model*. There are no provisions for carrying passengers safely. Vehicle stability and control may be severely affected. Never carry passengers.

3. Many accidents involve inexperienced riders. Most states require a special riding test or licence. Make sure you are qualified before you ride. **NEVER** lend your motorcycle to an inexperienced rider.
4. Many automobile/motorcycle accidents happen because the automobile driver does not “see” the rider. Make yourself conspicuous to help avoid the accident that wasn’t your fault:
 - Wear bright or reflective clothing.
 - Don’t ride in another motorist’s “blind spot.”

5. Obey all national and local laws and regulations.
 - Excessive speed is a factor in many accidents. Obey the speed limits, and NEVER travel faster than conditions warrant.
 - Signal before you make a turn or lane change to alert other motorists of your intentions.
6. Don't let other motorists surprise you. Use extra caution at intersections, parking lot entrances and exits, and driveways.
7. Riding on roads where other vehicles are traveling at greater rates of speed is not advisable. If you must ride in these conditions, be especially alert.
8. Keep both hands on the handlebar and both feet on the floor boards while riding.
9. Never leave your motorcycle unattended with the engine running.
10. Moderate your speed when riding over bumpy roads. Avoid hitting road hazards, such as sharp bumps and holes, in the road surface. These hazards can cause loss of control or structural damage to the vehicle.

PROTECTIVE APPAREL

ALWAYS wear a helmet.
You should also wear a face shield or goggles.

Clothes should be
close-fitting.

Wear gloves.

Wear bright or
reflective clothing.

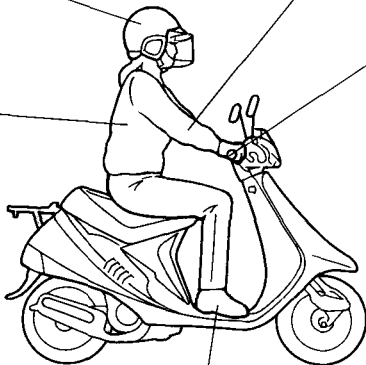

Shoes should be close-fitting, have low heels
and offer ankle protection.

MODIFICATIONS

⚠ WARNING

- * **Modification of the motorcycle, or removal of original equipment, may render the vehicle unsafe or illegal. Obey all national and local equipment regulations.**

LOADING AND ACCESSORIES

▲ WARNING

*** A motorcycle is sensitive to changes in weight distribution. Improper loading of cargo and mounting of accessories can impair the motorcycle's stability and performance. To prevent an accident, use extreme care when riding with cargo.**

These general guidelines may help you decide whether or how to equip your motorcycle, and how to load it safely.

1. The combined weight of the rider, cargo, and all accessories must not exceed the maximum weight capacity:

82 kg (180 lbs)

Do not exceed these following weight limits.

Glove Box (U type)	1.5 kg (3 lb)
Rear carrier (Rack)	5 kg (11 lb)
Front basket (U type)	3 kg (7 lb)

Overloading the motorcycle will adversely affect stability and handling.

2. Do not install another fairing or modify the existing one.
3. Do not carry items that protrude through the rack or block the taillight.
4. Do not carry children or pets on either carrier.
5. Keep cargo weight low and close to the center of the motorcycle. As weight is located further from the center of gravity, handling is proportionally affected. Load weight equally to minimize imbalance.

Overloading the motorcycle will adversely affect stability and handling.

Rear carrier;
never exceed the maximum
weight limit:
5 kg (11 lbs)
Be sure all cargo is
secure before riding.



U type
Glove box;
never exceed the maximum
weight limit:
1.5 kg (3 lbs)

PARTS LOCATION

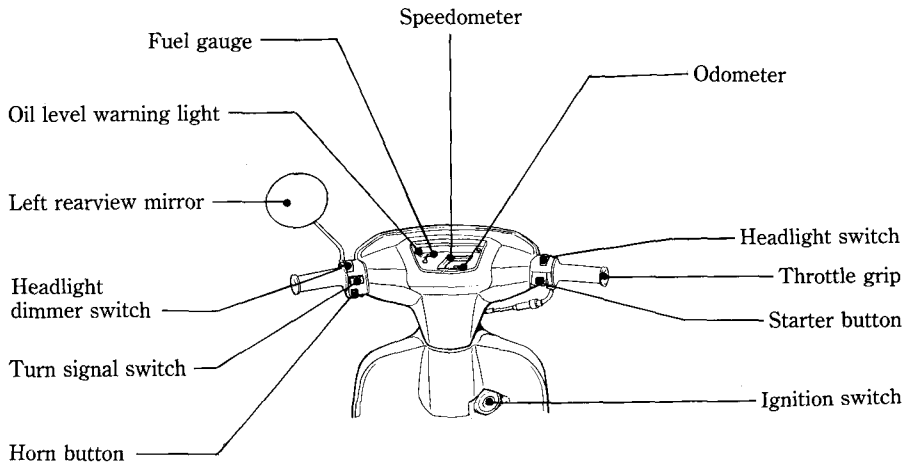

Front brake lever

Rear brake lever

Helmet holder

Oil tank cap

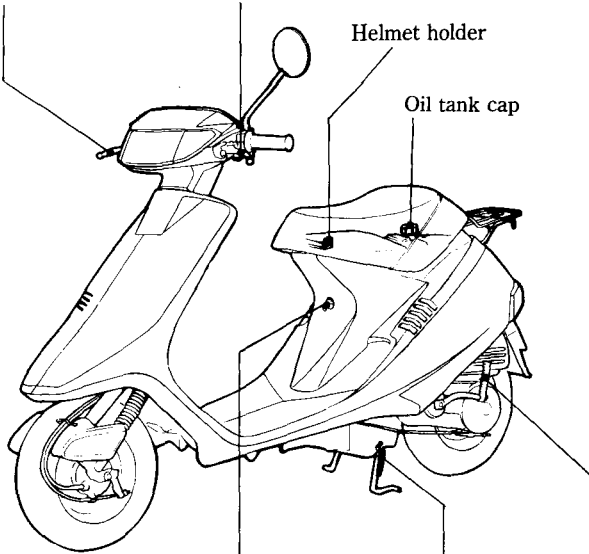

Fuel cock

Center stand

Kickstarter pedal

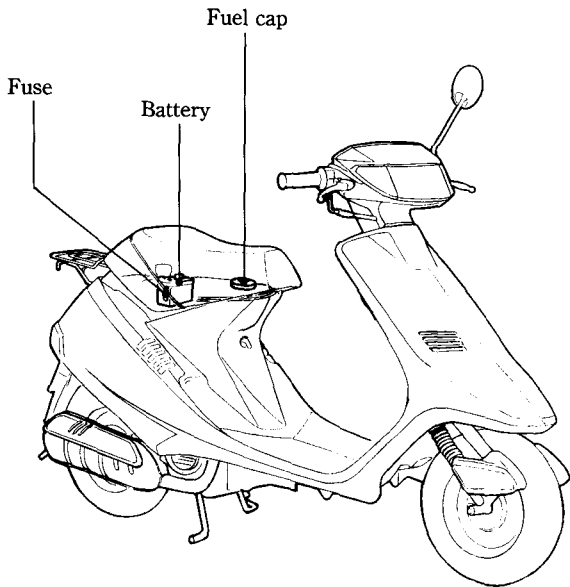

INSTRUMENTS AND INDICATORS

The indicators are grouped between the handlebars. Their functions are described in the table on the following page.

- (1) Oil level warning light
- (2) Fuel gauge
- (3) Speedometer
- (4) Odometer
- (5) Turn signal indicator (U type)
- (6) High beam indicator (U type)

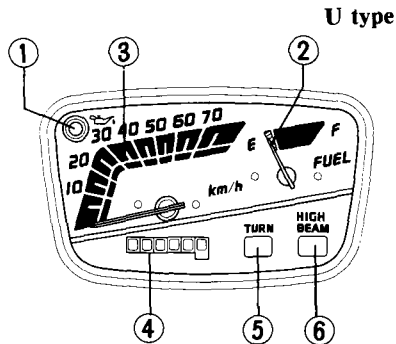
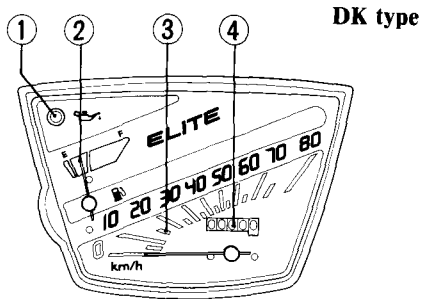

Ref. No.	Description	Function
1	Oil level warning light (red)	<p>The oil level warning indicator lights when the 2-stroke engine oil level is below approximately 0.2 l (0.21 US qt, 0.18 Imp qt).</p> <p>▲ WARNING</p> <p>* If the warning light comes on while riding, stop riding and shut the engine off. Fill the oil tank immediately to the UPPER LEVEL mark with the recommended oil (page 19). Do not ride if the oil level is low. Continuing to ride with a low oil level may lead to engine failure that could result in an accident.</p>
2	Fuel gauge	Shows approximate fuel supply available (see page 14).
3	Speedometer	Shows riding speed.
4	Odometer	Shows accumulated mileage.
5	Turn signal indicator (U type)	Flashes when either turn signal is operated.
6	High beam indicator (U type)	Lights when the headlight is on high beam.

Fuel Gauge

The fuel gauge (1) shows the approximate fuel supply available. At F (Full) there are 2.9 ℓ (0.77 US gal, 0.64 Imp gal) including the reserve supply.

When the gauge needle enters the red band (2), fuel will be low and you should refill the tank as soon as possible. The amount of fuel left in the tank when the needle enters the red band is approximately 0.8 ℓ (0.21 US gal, 0.18 Imp gal).

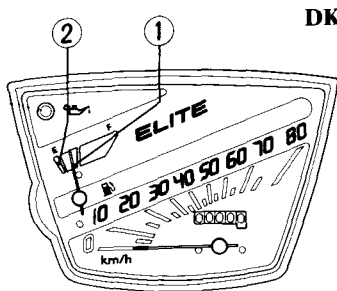

DK type

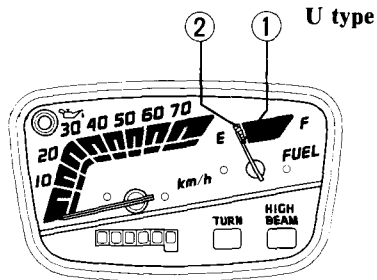

U type

(1) Fuel gauge

(2) Red band

MAJOR COMPONENTS (Information you need to operate this motorcycle)

⚠ WARNING

* If the Pre-ride Inspection (page 32) is not performed, severe personal injury or vehicle damage may result.

BRAKES

Adjustment:

1. Measure the distance the front brake lever

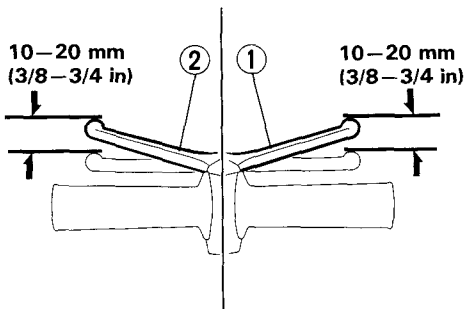

(1) Front brake lever (2) Rear brake lever

(1) and the rear brake lever (2) move before each brake starts to take hold. Free play at the tips of the brake levers should be:

10–20 mm (3/8–3/4 in)

2. Make free play adjustments by turning the adjusting nut (3) at the brake arm.

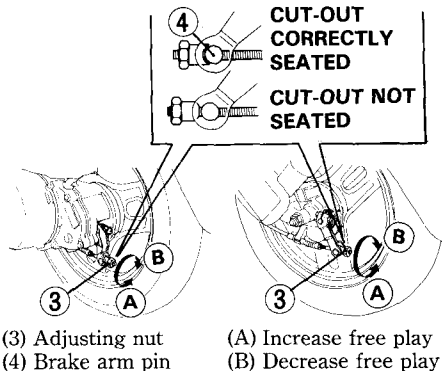

(3) Adjusting nut
(4) Brake arm pin

(A) Increase free play
(B) Decrease free play

Make sure the cut-out on the adjusting nut is seated on the brake arm pin (4) after making final free play adjustment.

3. Apply each brake several times and check for free wheel rotation when released.

NOTE:

- * If proper adjustment cannot be obtained by this method, see your authorized Honda dealer.

FUEL

Fuel Cock

The three way fuel cock (1) is on the front underneath the seat.

OFF

With the fuel cock in the OFF position, fuel cannot flow from the tank to the carburetor. Turn the cock OFF whenever the motorcycle is not in use.

ON

With the fuel cock in the ON position, fuel will flow from the main fuel supply to the carburetor.

RES

With the fuel cock in the RES position, fuel will flow from the reserve fuel supply to the carburetor. Use the reserve fuel only when the fuel gauge needle enters the red band (page 12). Refill the tank as soon as possible after switching to RES.

The reserve fuel supply is:

0.8 l (0.21 US gal, 0.18 Imp gal)

⚠ WARNING

- * To avoid running out of fuel that may result in a sudden stop, learn how to operate the fuel cock when riding the motorcycle.

NOTE:

- * Do not operate the motorcycle with the fuel cock in the RES position after refueling. You may run out of fuel with no reserve.

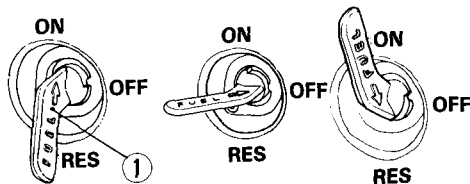

(1) Fuel cock

Fuel Tank

The fuel tank is located under the seat. Unlock and lift up the seat (page 30), then remove the fuel cap (1) by turning it counterclockwise. Fuel tank capacity is:

3 ℓ (0.79 US gal, 0.66 Imp gal)

Install the fuel tank cap by turning it clockwise. Use low-lead or unleaded petrol with an Octane number of 91 or higher.

FOR AUSTRALIA ONLY

Use unleaded fuel with a research octan number of 91 or higher.

CAUTION:

* If “spark knock” or “pinking” occurs at a steady engine speed under normal load, change brands of petrol. If spark knock or pinking persists, consult your authorized Honda dealer. Failure to do so is considered misuse, and damage caused by misuse is not covered by Honda’s Limited warranty.

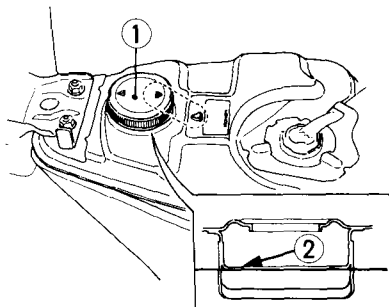

(1) Fuel cap

(2) Filler neck

▲ WARNING

- * **Petrol is extremely flammable and is explosive under certain conditions. Refuel in a well-ventilated area with the engine stopped. Do not smoke or allow flames or sparks in the area where the engine is refueled or where petrol is stored.**
- * **Do not overfill the tank (there should be no fuel in the filler neck (2)). After refueling, make sure the fuel cap is closed securely.**
- * **Be careful not to spill fuel when refueling. Spilled fuel or fuel vapor may ignite. If any fuel is spilled, make sure the area is dry before starting the engine.**
- * **Avoid repeated or prolonged contact with skin or breathing of vapor. KEEP OUT OF REACH OF CHILDREN.**

Petrol Containing Alcohol

If you decide to use a petrol containing alcohol (gasohol), be sure it's octane rating is at least as high as that recommended by Honda. There are two types of "gasohol": one containing ethanol, and the other containing methanol. Do not use petrol that contains more than 10% ethanol. Do not use petrol containing methanol (methyl or wood alcohol) that does not also contain cosolvents and corrosion inhibitors for methanol. Never use petrol containing more than 5% methanol, even if it has cosolvents and corrosion inhibitors.

NOTE:

- * Fuel system damage or engine performance problem resulting from the use of fuels that contain alcohol is not covered under the warranty. Honda cannot endorse the use of fuels containing methanol since evidence of their suitability is as yet incomplete.
- * Before buying fuel from an unfamiliar station, try to find out the fuel contains alcohol, if it does, confirm the type and percentage of alcohol used. If you notice any undesirable operating symptoms while using a petrol that contains alcohol, or one that you think contains alcohol, switch to a petrol that you know does not contain alcohol.

ENGINE OIL

Engine Oil Level Check

When the oil level indicator lights, it means the oil level in the oil tank is low; stop the engine and fill the oil tank as soon as possible.

▲ WARNING

- * **If the warning light comes on while riding, stop riding and shut the engine off. Fill the oil tank to the UPPER LEVEL mark with the recommended oil (see page 19). Continuing to ride with a low oil level may lead to engine failure that could result in an accident.**

CAUTION:

- * **If the engine has been run after the oil indicator light has come on, the motorcycle must be taken to an authorized Honda dealer for inspection and bleeding of the oil system. Failure to do this will result in serious engine damage.**

To fill, lift the seat (page 30), remove the cap (1) from the oil tank, and fill with the recommended oil up to the UPPER LEVEL mark (2).

Capacity:

1.0 ℓ (1.06 US qt, 0.88 Imp qt)

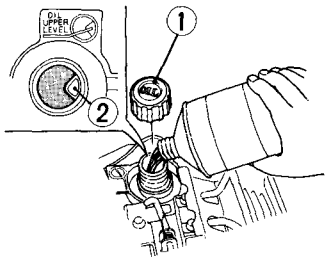

(1) Oil tank cap (2) UPPER LEVEL mark

Oil Recommendation:
USE HONDA 2-STROKE OIL OR ITS EQUIVALENT

CAUTION:

- * The use of improper oils may cause excessive and/or premature carbon build-up in the engine and exhaust system, resulting in loss of power and possible engine damage. Genuine Honda 2-Stroke Oil has been specifically designed and tested in Honda motorcycle and is a proper oil.

NOTE:

- * When filling, do not let dirt or other foreign materials enter the tank.

TYRES

Maintaining proper tyre pressure will provide maximum traction, stability, riding comfort and tyre life.

See your authorized Honda dealer for repair or replacement of tyres.

Pressure Check

Check tyre pressures frequently with a pressure gauge and adjust if necessary.

NOTE:

* Tyre pressure should be checked before you ride, while the tyres are "cold".

Check the tyres for cuts, embedded nails, or other sharp objects. See your authorized Honda dealer for replacement of damaged tyres or punctured inner tubes.

		DK type	U type
Cold tyre pressures kPa (kg/cm ² , psi)	FRONT	150 (1.5, 21)	125 (1.25, 18)
	REAR	175 (1.75, 24)	200 (2.00, 28)
Tyre size	FRONT	3.00-8-2PR	2.75-10-4PR
	REAR	3.00-8-2PR	2.75-10-4PR
The maximum weight capacity kg (lb)		82 (180)	

⚠ WARNING

- * **Improper tyre inflation will cause abnormal tread wear and create a safety hazard. Underinflation may result in the tyre slipping on, or coming off of the rim causing tyre deflation that may result in a loss of vehicle control.**
- * **Operation with excessively worn tyres is hazardous and will adversely affect traction and handling.**
- * **Do not attempt to patch a damaged tyre or inner tube. Wheel balance and tyre reliability may be impaired.**

Replace tyres before tread depth at the center of the tyre reaches the following limit:

Minimum tread depth	
Front:	1.5 mm (1/16 in)
Rear:	2.0 mm (3/32 in)

Cracks and Damage

Check the tyre tread and sidewalls for conspicuous cracks (1) or other damage (2).

⚠ WARNING

- * **Tyres that are cracked or damaged are a safety hazard. They may lose pressure rapidly, and a loss of vehicle control could result.**

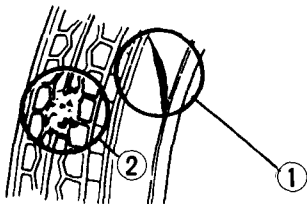

(1) Crack

(2) Damage

Abnormal Wear

Check for abnormal wear (3) of the tyre tread.

NOTE:

- * Abnormal wear will adversely affect traction and handling.

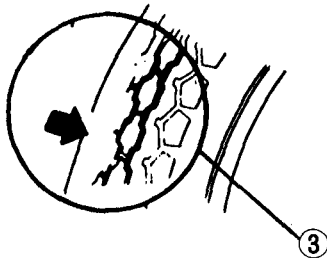

(3) Abnormal wear

Nails, Rocks and Other Sharp Objects

Check the tyre tread and sidewalls for nails, rocks, or other sharp objects (4).

▲ WARNING

- * Nails, rocks or other sharp objects may cause a puncture that could result in a loss of vehicle control.

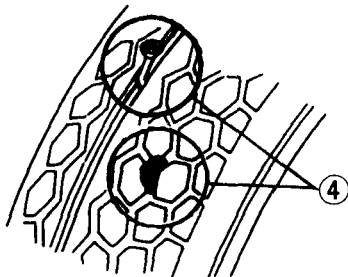

(4) Nails, rocks or other sharp objects

ESSENTIAL INDIVIDUAL COMPONENTS

IGNITION SWITCH

The ignition switch (1) is on the right side below the steering stem.

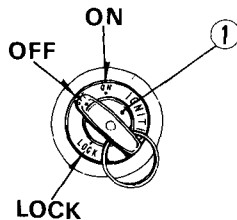

(1) Ignition switch

Key Position	Function	Key Removal
LOCK (Steering Lock)	The steering is locked. The engine and lights cannot be operated.	Key can be removed.
OFF	Engine and lights cannot be operated.	Key can be removed.
ON	Engine and lights can be operated. NOTE: * The headlight and instrument light operate whenever the engine is running.	Key cannot be removed.

HANDLEBAR CONTROLS

Headlight Switch (1) (DK type)

- ☰ — Headlight, taillight, and meter light will be on when the engine is running.
- — Headlight, taillight and meter light off.

DK type

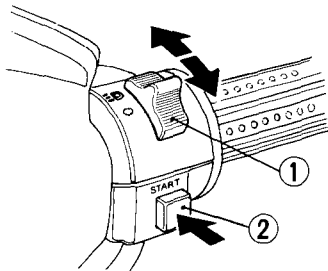

- (1) Headlight switch
- (2) Starter button

Starter Button (2)

The starter button (2) is below the headlight switch (1).

When the starter button is pressed, the starter motor cranks the engine. See page 33 for the starting procedure.

U type

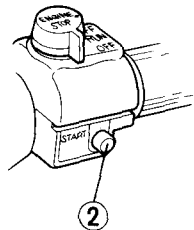

- (2) Starter button

Engine Stop Switch (3) (U type)

The three position engine stop switch (3) is next to the throttle grip. When the switch is in the RUN position, the engine will operate. When the switch is in either OFF position, the engine will not operate. This switch is intended primarily as a safety or emergency switch and should normally remain in the RUN position.

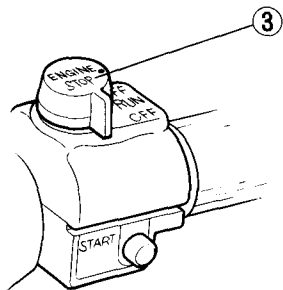

(3) Engine stop switch

• **DK type**

Headlight Dimmer Switch (1)

≡D — The high beam is on.

≡D — The low beam is on.

DK type

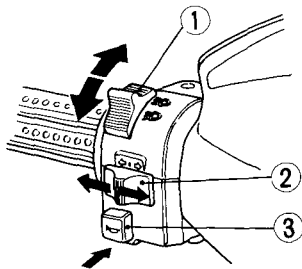

(1) Headlight Dimmer Switch

(2) Turn Signal Switch

(3) Horn Button

Turn Signal Switch (2)

Move to “←” to signal a left turn “→” to signal a right turn.

Return to the center (off) when finished.

Horn Button (3)

When the horn button is pressed, the horn will sound.

- **U type**

- **Headlight Dimmer Switch (1)**

- Select Hi for high beam, Lo for low beam.

- **Turn Signal Switch (2)**

- Move to L to signal a left turn, R to signal a right turn. Return to the center (off) when finished.

- **Horn Button (3)**

- Press the button to sound the horn.

- **Headlight Switch (4)**

-  — Headlight, taillight and meter light will be on when the engine is running.
 - — Headlight, taillight and meter light off.

U type

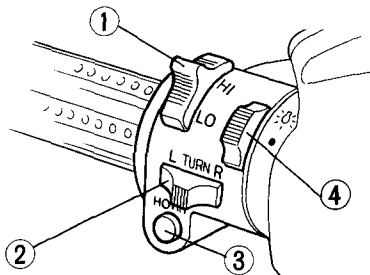

- (1) Headlight dimmer switch
- (2) Turn signal switch
- (3) Horn button
- (4) Headlight switch

FEATURES (Not required for operation)

STEERING LOCK

To Lock:

To lock the steering, turn the handlebars all the way to the left, and turn the key (1) to Lock. Remove the key.

▲ WARNING

- * Do not turn the key to LOCK while riding the motorcycle; loss of control will occur.

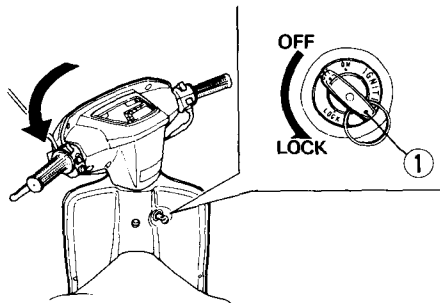

(1) Ignition key

HELMET HOLDER

The helmet holder (1) eliminates the need for carrying your helmet after parking. Insert the ignition key into the seat lock, and turn it clockwise to unlock.

Hang your helmet on the hook at the seat hinge and lower the seat to lock. To remove a helmet, unlock the seat. Lift the helmet off the holder and lower the seat, making sure it is securely locked before riding.

▲ WARNING

* **The helmet holder is designed for helmet security while the motorcycle is parked. Do not operate the motorcycle with a helmet attached to the holder; the helmet may interfere with the safe operation of the motorcycle.**

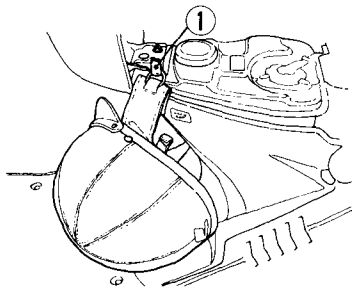

(1) Helmet holder

SEAT LOCK

The seat lock (1) is on the left side below the seat.

To lift the seat, insert the ignition key (2) and turn it clockwise to unlock.

To lock the seat, lower and push down on it until it locks. Make sure the seat is secure before riding.

CAUTION:

* Before locking the seat, make sure you have not left the ignition key in the compartment under it.

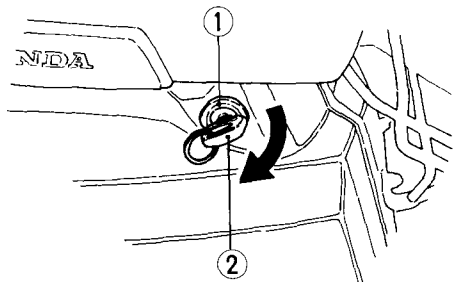

(1) Seat lock

(2) Ignition key

DOCUMENT BAG

Your motorcycle is equipped with a document bag behind the seat.

This owner's manual and other documents should be stored in the document bag. When washing your motorcycle, be careful not to flood this area with water.

OPERATION

PRE-RIDE INSPECTION

▲ WARNING

- * If the Pre-ride Inspection is not performed, severe personal injury or vehicle damage may result.**

Inspect your motorcycle, and perform any needed adjustments or repairs, every day before you ride it. The items listed here will only take a few minutes to check and, in the long run, can save time, expense, and possibly your life.

1. Oil level—check the level and if necessary, add oil (page 18).
2. Fuel level—fill fuel tank when necessary (page 15). Check for leaks.
3. Front and rear brakes—check operation and if necessary, adjust free play (pages 13–14).
4. Tyres—check condition and pressure (pages 20–22).
5. Throttle—check for smooth opening and closing in all steering positions.
6. Lights and horn—check that the headlight, tail/stoplight, turn signals, indicators and horn function properly.

7. Engine stop switch (U type)-check for proper function (page 25).

Correct any discrepancy before you ride. Contact your authorized Honda dealer for assistance if you cannot correct the problem.

STARTING THE ENGINE

NOTE:

- * Operate the kickstarter or starter button for slightly longer than usual without opening the throttle if the motorcycle has been left standing for a long time or when the fuel tank has just been refilled.

1. Place the motorcycle on its center stand.

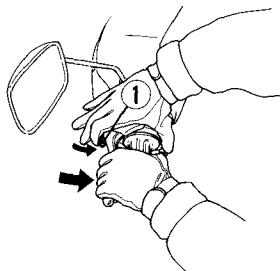

(1) Lock lever

2. Lock the rear wheel by squeezing the brake lever and setting the lock lever (1).

⚠ WARNING

- * **The rear wheel will spin if not restrained by the brake or by contact with the ground. Accidental contact with a spinning rear wheel could cause personal injury.**

NOTE:

- * The electric starter will only work when the brake lever (2) is operated.

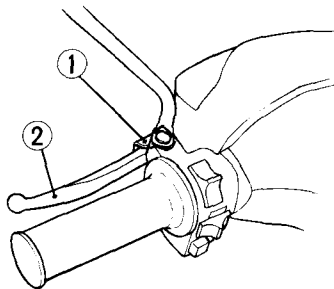

(2) Rear brake lever

3. Turn the fuel cock (3) ON.

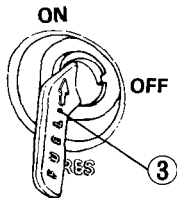

(3) Fuel cock

4. Turn the ignition switch (4) to ON.

▲ WARNING

* **Never run the engine in a closed area. The exhaust contains poisonous carbon monoxide gas that can cause loss of consciousness and may lead to death.**

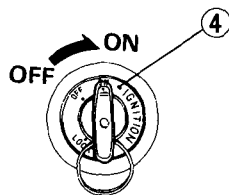

(4) Ignition switch

5. With the throttle closed, push the starter button (5). Release the starter button as soon as the engine starts.

NOTE:

- * Do not use the electric starter for more than 5 seconds at a time. Release the starter button for approximately 10 seconds before pressing it again.

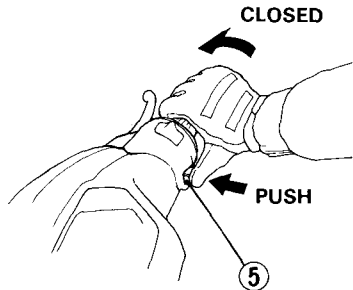

(5) Starter button

6. Be sure to keep the throttle (6) closed and the rear brake (7) locked while starting and warming up the engine.
7. Allow the engine to warm up before riding (See "RIDING," page 38).

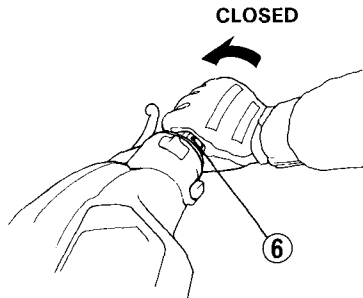

(6) Throttle

⚠ WARNING

- * Do not “BLIP” the throttle (open and close rapidly) as the motorcycle will move forward suddenly, causing possible loss of control.
- * Do not leave the motorcycle unattended while the engine is warming up.

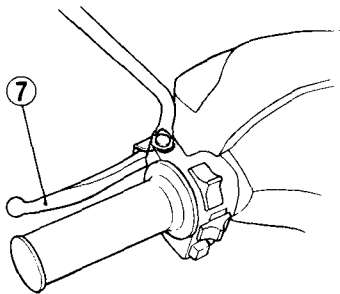

(7) Rear brake lever

To start the engine without the electric starter,

1. Follow steps 1 through 4.
2. With the throttle closed, operate the kickstarter with a rapid, continuous motion.

CAUTION:

- * Do not allow the kickstarter to snap back freely against the pedal stop as engine case damage could result.
 - * Raise up the kickstarter pedal after the kickstarter lever is returned to the stop.
3. Follow steps 6 through 7.

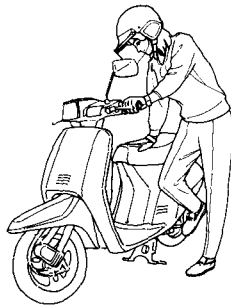

If you cannot restart a warm engine:

1. Place the motorcycle on its center stand and set the parking brake.
2. Open the throttle (1) $1/8$ — $1/4$ turn while starting the engine.

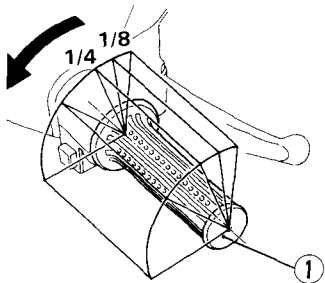

(1) Throttle

RUNNING-IN

During the first 1,000 km (600 miles), do not operate the motorcycle at more than 80% of the maximum speed.

Avoid full throttle operation, and do not operate for a long time at one speed.

During initial running-in newly machined surfaces will be in contact with each other and these surfaces will wear in quickly. Running-in maintenance at 1,000 km (600 miles) is designed to compensate for this initial minor wear. Timely performance of the running-in maintenance will ensure optimum service life and performance from the engine.

RIDING

⚠ WARNING

- * Do not wear loose clothing which may catch on control levers, wheels and tyres.
- * Ensure that all required equipment as specified by local laws and regulations are installed on the motorcycle and operable before riding it on public streets.

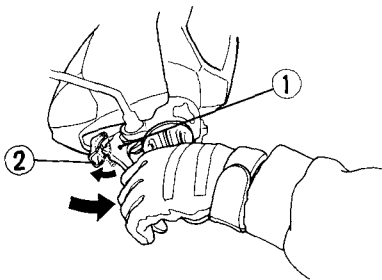

(1) Rear brake lever (2) Lock lever

1. Make sure the throttle is closed and the rear brake is locked (page 33) before moving the motorcycle off the center stand.

⚠ WARNING

- * **The rear wheel must be locked when moving the motorcycle off the center stand or loss of control may result.**
2. Stand on the left side of the motorcycle and push it forward and off the center stand.

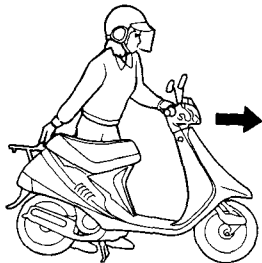

3. Mount the motorcycle from the left side keeping at least one foot on the ground to steady the motorcycle.



4. Unlock the rear wheel by squeezing and releasing the rear brake lever (1).

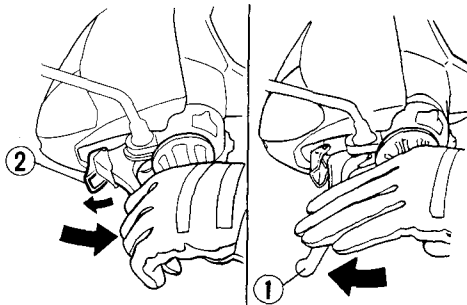

- (1) Rear brake lever (2) Lock lever

5. **Before starting off**, indicate your direction with the turn signals, and check for safe traffic conditions.

Grasp the handlebars firmly with both hands.

⚠ WARNING

- * **Never attempt one-handed operation; loss of vehicle control could result.**

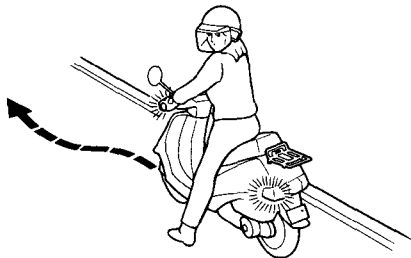

6. **To accelerate**, open the throttle (1) gradually; the motorcycle will move forward.

⚠ WARNING

- * **Do not “BLIP” the throttle (open and close rapidly) as the motorcycle will move forward suddenly, causing possible loss of control.**
7. **To decelerate**, close throttle.

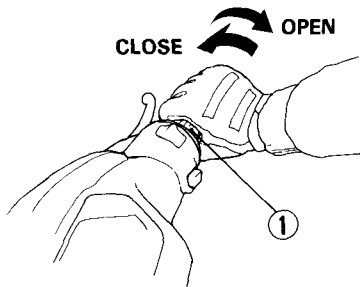

(1) Throttle

8. When slowing down the motorcycle, coordination of the throttle (1) and front and rear brakes (2) is most important.

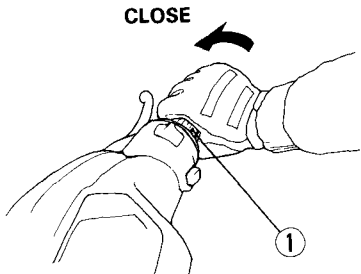

(1) Throttle

⚠ WARNING

- * Both front and rear brakes should be applied together. Independent use of only the front or rear brake reduces stopping performance. Excessive brake application may cause either wheel to lock, reducing control of the motorcycle.

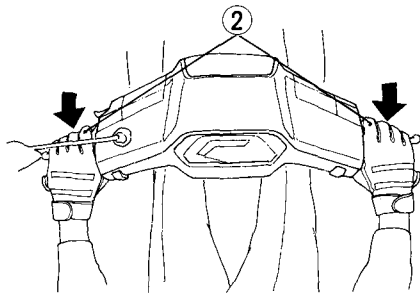

(2) Front and rear brakes

9. **When approaching a corner or turn,** close the throttle (1) fully, and slow the motorcycle down by applying both front (2) and rear (3) brakes at the same time.

10. After completing the turn, open the throttle gradually to accelerate the motorcycle.

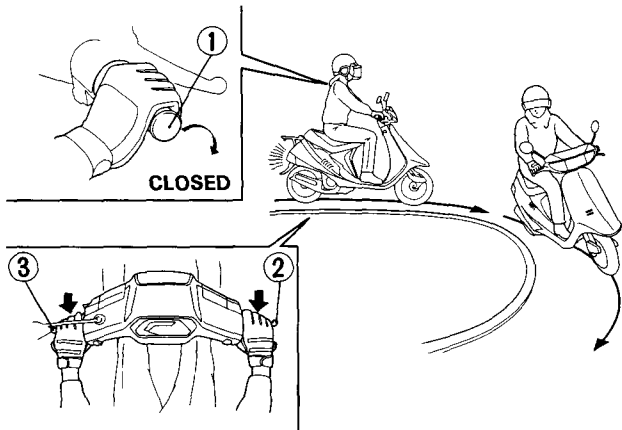

(1) Throttle (2) Front brake (3) Rear brake

11. **When descending a steep grade,** close the throttle (1) fully and apply both brakes (2) to slow the motorcycle down.

CAUTION:

- * **Avoid continuous use of the brakes, which may result in overheating and reduction of braking efficiency.**

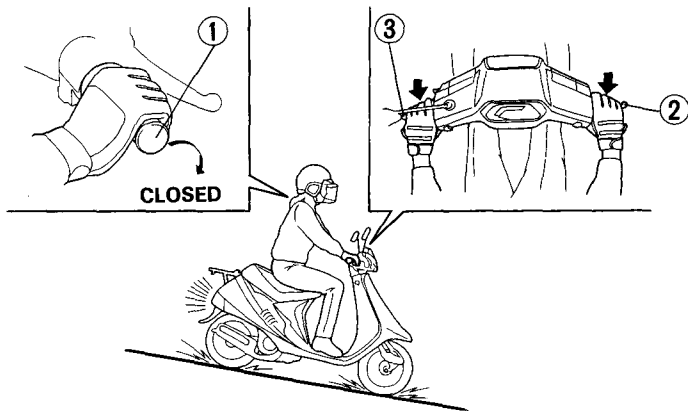

(1) Throttle (2) Front brake (3) Rear brake

12. When riding on wet or loose surfaces, be especially cautious.

▲ WARNING

- * **When riding in wet or rainy conditions or on loose surfaces, the ability to maneuver and stop will be reduced.**

For your safety:

- **Exercise extreme caution when braking, accelerating or turning.**
- **Ride at slower speeds and allow for extra stopping distance.**
- **Keep the motorcycle as upright as possible.**
- **Use extreme caution when riding over slippery surfaces such as railroad tracks, iron plates, manhole covers, painted lines, etc.**

High Altitude Riding

When operating this motorcycle at high altitude, the air-fuel mixture becomes overly rich. Above 2,000 m (6,500 feet), driveability and performance may be reduced and fuel consumption increased.

The carburetor can be modified to compensate for this high altitude richness. However the carburetor must be returned to standard factory specifications when lower altitude riding is desired. See your authorized Honda dealer for high altitude adjustments.

CAUTION:

- * **Sustained operation at altitudes below 1,500 m (5,000 feet) with high altitude carburetor modifications may cause engine overheating and damage.**

PARKING

1. After stopping the motorcycle, turn the ignition switch to the "OFF" position and remove the key.
2. Use the center stand to support the motorcycle while parked.

CAUTION:

- * **Park the motorcycle on firm, level ground to prevent it from falling over.**

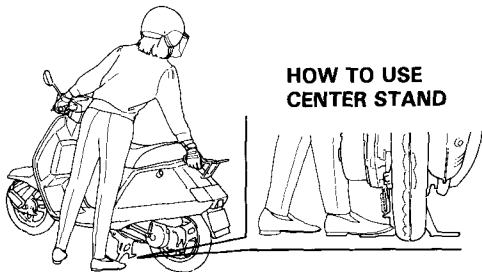

3. Lock the steering to help prevent theft (page 28).

⚠ WARNING

- * **The exhaust pipe and muffler become very hot during operation and remain sufficiently hot to inflict burns if touched, even after shutting off the engine.**

ANTI-THEFT TIPS

1. Always lock the steering and never leave the key in the ignition switch. This sounds simple but people do forget.
2. Be sure the registration information for your motorcycle is accurate and current.
3. Park your motorcycle in a locked garage whenever possible.
4. Use an additional anti-theft device of good quality.
5. Put your name, address, and phone number in this Owner's Manual and keep it on your motorcycle at all times.

Many times stolen motorcycles are identified by information in the Owner's Manuals that are still with them.

NAME: _____

ADDRESS: _____

PHONE NO.: _____

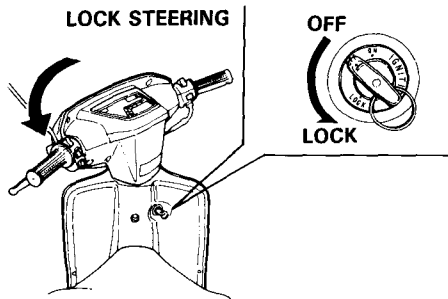

MAINTENANCE

- When service is required, remember that your authorized Honda dealer knows your motorcycle best and is fully equipped to maintain and repair it. The scheduled maintenance may also be performed by a qualified service facility that normally does this kind of work; or you may perform most of the work yourself if you are mechanically qualified.
- The maintenance intervals shown in the following schedule are based upon average riding conditions. Motorcycles subjected to severe use, or ridden in unusually muddy or dusty areas, require more frequent servicing.
- Consult your authorized Honda dealer for recommendations applicable to your individual needs and use.

MAINTENANCE SCHEDULE

Perform the Pre-ride Inspection (page 30) at each scheduled maintenance period.

I: INSPECT AND CLEAN, ADJUST, LUBRICATE OR REPLACE IF NECESSARY

C: CLEAN R: REPLACE A: ADJUST L: LUBRICATE

ITEM		FREQUENCY	WHICHEVER →		ODOMETER READING [NOTE (1)]				Refer to pages
			COMES FIRST ↓		x 1,000 km	1	4	8	
		NOTE	MONTH	x 1,000 mi	0.6	2.5	5	7.5	
*	FUEL LINE				—	I	I	I	—
*	THROTTLE OPERATION				—	I	I	I	—
**	OIL PUMP AND OIL LINE				—	I	I	I	—
	AIR CLEANER		NOTE 2		—	C	C	C	52-53
	SPARK PLUG				EVERY 1,600 km (1,000 mi) R				54-55
**	DECARBONIZING				EVERY 3,200 km (2,000 mi) C				—
*	CARBURETOR-IDLE SPEED				I	I	I	I	56

ITEM	FREQUENCY	WHICHEVER COMES FIRST ↓ NOTE	ODOMETER READING [NOTE (1)]					Refer to pages
			WHICHEVER →					
			MONTH	x 1,000 km	x 1,000 mi	1	4	
	BRAKE SHOE WEAR			—	I	I	I	57
	BRAKE SYSTEM			I	I	I	I	13-14
*	BRAKE LIGHT SWITCH			—	I	I	I	—
*	HEADLIGHT AIM			—	I	I	I	—
**	CLUTCH SHOE WEAR			—	—	I	—	—
*	SUSPENSION			—	I	I	I	—
*	NUTS, BOLTS, FASTENERS			I	—	I	—	—
**	WHEEL/TYRES			—	I	I	I	—
**	STEERING HEAD BEARINGS			I	—	—	I	—

* SHOULD BE SERVICED BY YOUR AUTHORIZED HONDA DEALER UNLESS THE OWNER HAS PROPER TOOLS AND SERVICE DATA AND IS MECHANICALLY QUALIFIED. REFER TO THE OFFICIAL HONDA SERVICE MANUAL.

** IN THE INTEREST OF SAFETY, WE RECOMMEND THESE ITEMS BE SERVICED ONLY BY AN AUTHORIZED HONDA DEALER.

NOTE: (1) For higher odometer readings, repeat at the frequency interval established here.

(2) Service more frequently when riding in unusually wet or dusty areas.

SERIAL NUMBERS

The frame and engine serial numbers are required when registering your motorcycle. They may also be required by your authorized Honda dealer when ordering replacement parts. Record the numbers here for your reference.

FRAME NO. _____

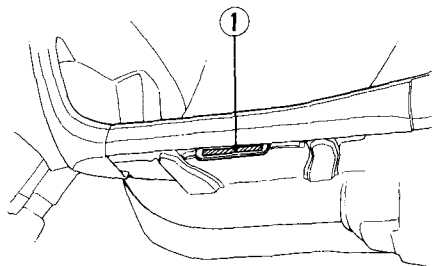

(1) Frame number

The frame number (1) is stamped on the left side of the frame body.

The engine number (2) is stamped on the back of the crankcase near the rear wheel.

ENGINE NO. _____

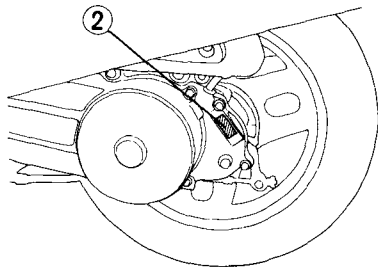

(2) Engine number

COLOUR LABEL

The colour label (1) is attached to the fuel tank below the seat. It is helpful when ordering replacement parts. Record the colour and code here for your reference.

COLOUR _____

CODE _____

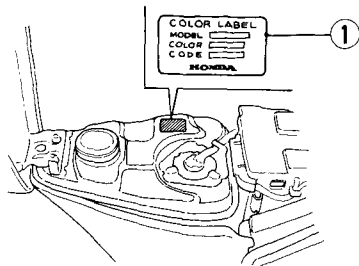

(1) Colour label

MAINTENANCE PRECAUTIONS

▲ WARNING

- * If your motorcycle is overturned or involved in a collision, inspect control levers and cables, switches and other vital parts for damage. Do not ride the motorcycle if damage impairs safe operation. Have your authorized Honda dealer inspect the major components including frame, suspension, and steering parts for misalignment and damage that you may not be able to detect.
- * Before performing any maintenance, stop the engine and support the motorcycle on a firm, level surface.
- * Use new, genuine Honda parts or their equivalent for maintenance and repair.
Parts which are not of equivalent quality may impair the safety of your motorcycle.

AIR CLEANER

(Refer to the maintenance precautions on page 51).

The air cleaner should be serviced at regular intervals (page 48). Service more frequently when riding in dusty areas.

1. Remove the three screws (1).
2. Loosen and remove the two screws (2) with clips (3).

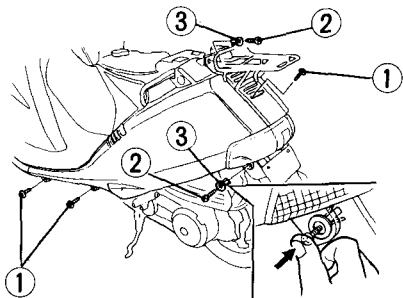

(1) Screws
(2) Screws

(3) Clips

3. Detach the hooks (4) on the rear part of the left side cover (5) first, and then detach the hooks (6) on the front part.

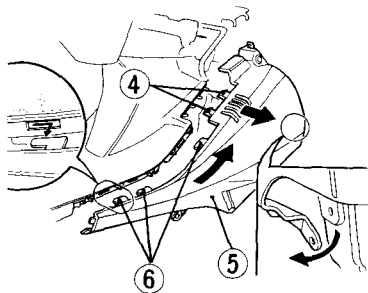

(4) Hooks

(5) Left side cover

(6) Hooks

4. Remove the air cleaner case cover (7) by removing the five screws (8).
5. Wash the element (9) in clean, nonflammable or high flash point solvent and let it dry thoroughly.

⚠ WARNING

* Never use petrol or low flash point solvents for cleaning the air cleaner element. A fire or explosion could result.

6. Soak the element in gear oil (SAE 80–90) until saturated, then squeeze out the excess oil.
7. Installation Notes:
 - Reverse the removal procedure.
 - Make sure to engage all tabs on the side cover and to secure the screws.

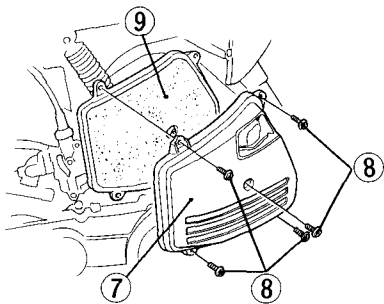

- (7) Air cleaner case cover (8) Screws
(9) Air cleaner element

SPARK PLUG

(Refer to the maintenance precautions on page 51.)

Recommended plugs:

Standard:

BP6HSA (NGK) or
W20FP-L (ND)

For cold climate (Below 5°C, 41°F):

BP4HSA (NGK) or
W14FP-L (ND)

For extended high speed riding:

BP8HSA (NGK) or
W24FP-L (ND)

1. Remove the side cover (page 52).
2. Disconnect the spark plug cap.
3. Clean any dirt from around the spark plug base. Remove and discard the spark plug.
4. Make sure the spark plug gap (1) is 0.6–0.7 mm (0.024–0.028 in) using a wire-type feeler gauge. If adjustment is necessary, bend the side electrode (2) carefully.

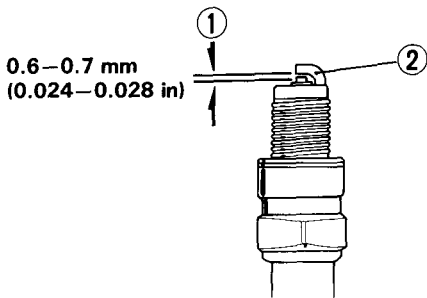

(1) Spark plug gap

(2) Side electrode

5. With the plug washer attached, thread the new spark plug in by hand to prevent cross-threading.
6. Tighten the spark plug 1/2 turn with a spark plug wrench to compress the washer.
7. Connect the plug cap, and replace the side cover.

⚠ WARNING

- * **Never leave shop towels in the engine area after cleaning the spark plug base.**
They may cause the engine to overheat and become damaged.

CAUTION:

- * **The spark plug must be securely tightened. An improperly tightened plug can become very hot and possibly damage the engine.**
- * **Never use a spark plug with an improper heat range.**

IDLE SPEED

(Refer to the maintenance precautions on page 51).

The engine must be at normal operating temperature for accurate idle speed adjustment. Ten minutes of stop-and-go riding is sufficient.

NOTE:

* Do not attempt to compensate for faults in other systems by adjusting idle speed. See your authorized Honda dealer for regularly scheduled carburetor adjustments.

1. Warm up the engine and place the motorcycle on its center stand.
2. Connect a tachometer to the engine.
3. Adjust the idle speed with the throttle stop screw (1).

IDLE SPEED:

$1,800 \pm 100 \text{ min}^{-1}$ (rpm)

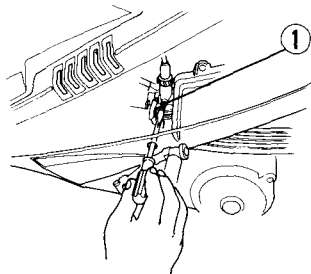

(1) Throttle stop screw

BRAKE SHOE WEAR

(Refer to the maintenance precautions on page 51).

Wear Indicator

When the brake is applied, an arrow (1) attached to the brake arm (2) moves toward a reference mark (3) on the brake panel.

If the arrow aligns with the reference mark on full application of the brake, the brake shoes must be replaced.

(FRONT)

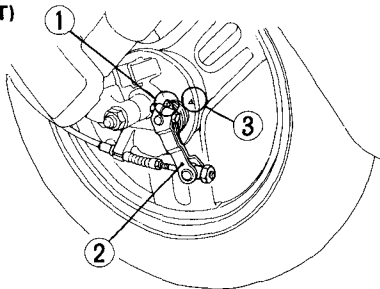

(1) Arrow

(2) Brake arm

NOTE:

- * When the brake service is necessary, see your authorized Honda dealer, who has been properly trained to perform such service. Use only genuine Honda parts or its equivalent.

Other Checks

Check the brake cable for kinks or signs of wear that could cause sticking or failure.

Lubricate the brake cable with a commercially available cable lubricant to prevent premature wear and corrosion.

Make sure the brake arm, spring and fasteners are in good condition.

(REAR)

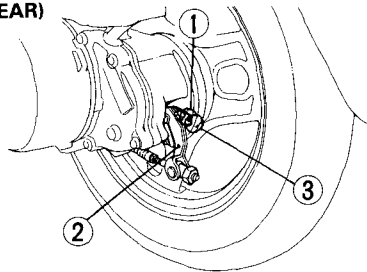

(3) Reference mark

BATTERY

(Refer to the maintenance precautions on page 51).

It is not necessary to check the battery electrolyte level or add distilled water as the battery is a maintenance-free (sealed) type. If the battery loses electrolyte and/or seems weak (causing hard starting or other electrical troubles), contact your authorized Honda dealer.

⚠ WARNING

- * The battery gives off explosive gases; keep sparks, flames, and cigarettes away. Provide adequate ventilation when charging or using the batteries in an enclosed space.
- * The battery contains sulfuric acid (electrolyte). Contact with skin or eyes may cause severe burns. Wear protective clothing and a face shield.
 - If electrolyte gets on your skin, flush with water.
 - If electrolyte gets in your eyes, flush with water for at least 15 minutes and call a physician immediately.

- * Electrolyte is poisonous.
 - If swallowed, drink large quantities of water or milk and follow with milk of magnesia or vegetable oil and call a physician.
- * **KEEP OUT OF REACH OF CHILDREN.**

CAUTION:

- * Do not attempt to remove the sealing caps from the cells—you may damage the battery.
- * When the motorcycle is to be stored for an extended period of time, remove the battery from the motorcycle and charge it fully. Then store it in a cool, dry place. If the battery is to be left in the motorcycle, disconnect the negative cable from the battery terminal.

FUSE REPLACEMENT

(Refer to the maintenance precautions on page 51).

The fuse holder (1) is near the battery.

When frequent fuse failure occurs, it usually indicates a short circuit or an overload in the electrical system. If this happens, the electrical system should be checked visually for damaged insulation or other possible malfunctions. If the problem cannot be located visually, the motorcycle should be examined by an authorized Honda dealer.

The specified fuse is:

7 Amp (DK type)

10 Amp (U type)

▲ WARNING

*** Never use a fuse with a different rating from that specified. Serious damage to the electrical system or a fire may result, causing a dangerous loss of lights or engine power at night or in traffic.**

CAUTION:

*** Turn the ignition switch OFF before checking or replacing the fuse to prevent accidental short-circuiting.**

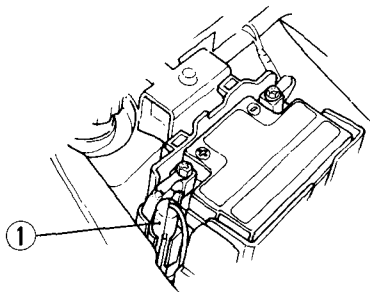

(1) Fuse holder

⚠ WARNING

- * Do not pry the clips open to get a fuse out; you could bend them and cause poor contact with the new fuse. A loose fuse could cause damage to the electrical system and even start a fire.

To replace the fuse, open the fuse holder and lift out the fuse with the clips. Slide the old fuse out of the clips and discard it. Slide the clips onto the ends of the new fuse, push them back into the fuse holder, and close the fuse holder.

CAUTION:

- * After replacing the fuse, be sure to return the fuse holder to its original location.

REMOVAL

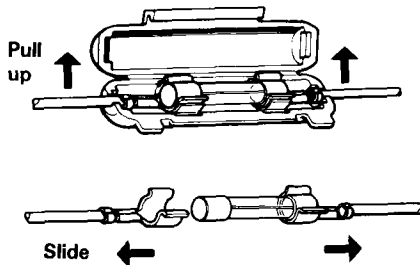

INSTALLATION

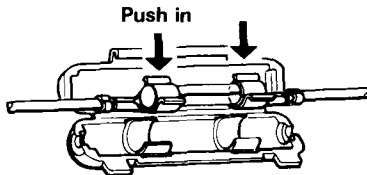

TRANSPORTING

▲ WARNING

- * To prevent the possibility of a fire or explosion when transporting the motorcycle, always:
 - Drain the fuel tank and carburetor.
 - Carry the motorcycle upright in its normal riding position to prevent oil and battery electrolyte from leaking.

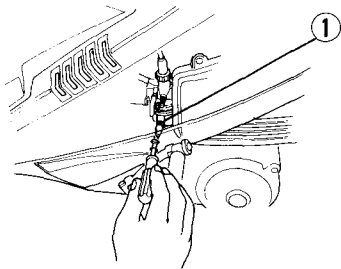

(1) Drain screw

Draining Fuel

Perform this operation only in a well-ventilated area.

▲ WARNING

- * **Petrol is flammable and is explosive under certain conditions. Do not smoke or allow flames or sparks in the area when draining or refueling.**
1. Stop the engine.
 2. Empty the fuel tank using a commercially available hand siphon or other equivalent way.
 3. Place the free end of the carburetor drain tube in a suitable container.
 4. Open the carburetor drain by turning the drain screw (1) counterclockwise. When all the fuel has drained, turn the screw clockwise until tight.

CLEANING

Clean your motorcycle regularly to protect the surface finishes and inspect it for damage, wear and oil seepage.

CAUTION:

- * **Avoid spraying high pressure water (typical in coin-operated car washes) at the following areas:**

Wheel Hubs

Muffler Outlet

Under Seat

Ignition Switch

Handlebar Switches

1. After cleaning, rinse the motorcycle thoroughly with plenty of clean water. Strong detergent residue can corrode alloy parts.
2. Dry the motorcycle thoroughly.
3. Start the engine and let it run for several minutes.

4. Test the brakes before riding the motorcycle in traffic. Several applications may be necessary to restore normal braking performance.

⚠ WARNING

- * **Braking performance may be impaired immediately after washing the motorcycle.**

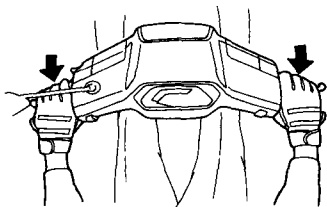

TEST BRAKES

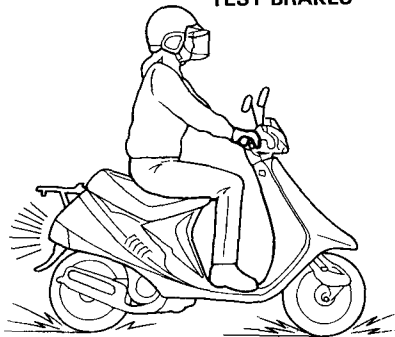

STORAGE GUIDE

STORAGE

Extended storage, such as for winter, requires that you take certain steps to reduce the effects of deterioration from non-use of the motorcycle. In addition necessary repairs should be made **BEFORE** storing the motorcycle: otherwise these repairs may be forgotten by the time the motorcycle is removed from storage.

1. Drain the fuel tank and carburetor.
Spray the inside of the tank with an aerosol rust-inhibiting oil.
Reinstall the fuel cap on the tank.

NOTE:

- * If storage will last more than one month, carburetor draining is very important, to assure proper performance after storage.

WARNING

- * **Petrol is flammable and is explosive under certain conditions. Do not smoke or allow flames or sparks near the equipment while draining fuel.**

2. Remove the spark plug and pour a tablespoon (15–20 cm³) of clean 2-stroke oil into the cylinder.

Operate the kickstarter several times to distribute the oil, then reinstall the spark plug.

NOTE:

- * When turning the engine over, the Ignition Switch should be OFF.

3. Remove the battery. Store in an area protected from freezing temperatures and direct sunlight.
Slow charge the battery once a month.
4. Wash and dry the motorcycle.
Wax all painted surfaces.
5. Inflate the tyres to their recommended pressures. Place the motorcycle on blocks to raise both tyres off the ground.
6. Cover the motorcycle (don't use plastic or other coated materials) and store in an unheated area, free of dampness and with a minimum of daily temperature variation. Do not store the motorcycle in direct sunlight.

REMOVAL FROM STORAGE

1. Uncover and clean the motorcycle.
2. Check the voltage and slow charge the battery if it is below 12.3V.
3. Drain any excess aerosol rust-inhibiting oil from the fuel tank. Fill the fuel tank with fresh petrol.
4. Perform all Pre-ride Inspection checks (page 32).
Test ride the motorcycle at low speeds in a safe riding area away from traffic.

SPECIFICATIONS

DIMENSIONS

Overall length	1,570 mm (61.8 in)	U: 1,650 mm (64.9 in)
Overall width	590 mm (23.2 in)	U: 620 mm (24.4 in)
Overall height	990 mm (39.0 in)	U: 1,030 mm (40.6 in)
Wheelbase	1,165 mm (45.9 in)	U: 1,180 mm (46.5 in)
Ground clearance	100 mm (3.9 in)	U: 110 mm (4.3 in)

WEIGHT

Dry weight	56 kg (123.5 lbs)	U: 58 kg (127.9 lbs)
------------	-------------------	----------------------

CAPACITIES

2 stroke engine oil	1.0 ℓ (1.06 US qt, 0.88 Imp qt)
Transmission oil	90 cc (3.0 US oz, 3.2 Imp oz) at disassembly
Fuel tank	2.9 ℓ (0.77 US gal, 0.64 Imp gal)
Passenger capacity load	Operator only. No passenger
Maximum weight capacity	82 kg (180 lb)

ENGINE

Bore and stroke	41 x 37.4 mm (1.61 x 1.47 in)
Compression ratio	6.6 : 1
Displacement	49.4 cm ³ (3.0 cu.in)
Spark plug	
Standard	BP6HSA (NGK) W20FPR-L (ND)
For cold climate (Below 5°C, 41°F)	BP4HSA (NGK) W14FPR-L (ND)
For extended high speed riding	BP8HSA (NGK) W24FPR-L (ND)
Spark plug gap	0.6—0.7 mm (0.024—0.028 in)
Idle speed	1,800 ± 100 min ⁻¹ (rpm)

CHASSIS AND SUSPENSION

Caster	26°30' U: 27°30'
Trail	56 mm (2.2 in) U: 70 mm (2.8 in)
Tyre size, front	3.00-8-2PR U: 2.75-10-4PR
Tyre size, rear	3.00-8-2PR U: 2.75-10-4PR

POWER TRANSMISSION

Primary reduction
Final reduction

V-Belt
11.097

ELECTRICAL

Battery
Generator

12V-3AH
A.C. GENERATOR

LIGHTS

Headlight (HIGH/LOW)
Tail/stoplight
Turn signal light
Instrument lights

12V-25/25W
12V-5/18W
12V-10W x 4 U: 12V-23W x 4
12V-3.4W

FUSE

7A U: 10A

NOISE CONTROL SYSTEM (AUSTRALIA ONLY)

TAMPERING WITH NOISE CONTROL SYSTEM PROHIBITED

Owners are warned that the law may prohibit:

- (a) The removal or rendering inoperative by any person other than for purposes of maintenance, repair or replacement, of any device or element of design incorporated into any new vehicle for the purpose of noise control prior to its sale or delivery to the ultimate purchaser or while it is in use; and
- (b) the use of the vehicle after such device or element of design has been removed or rendered inoperative by any person.

SE50M (U type)

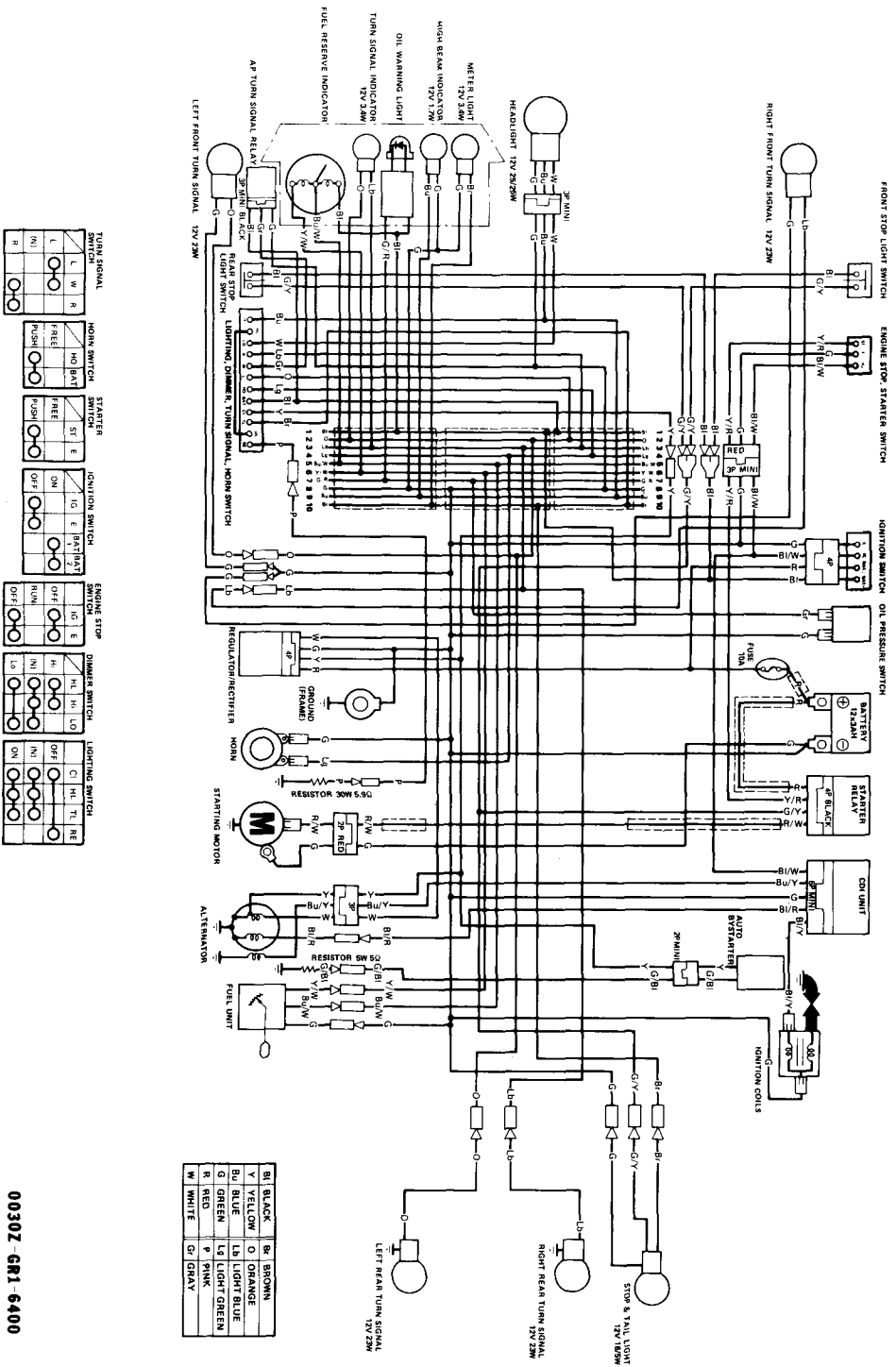

0030Z - GR1 - 6400

SE50 (DK type)

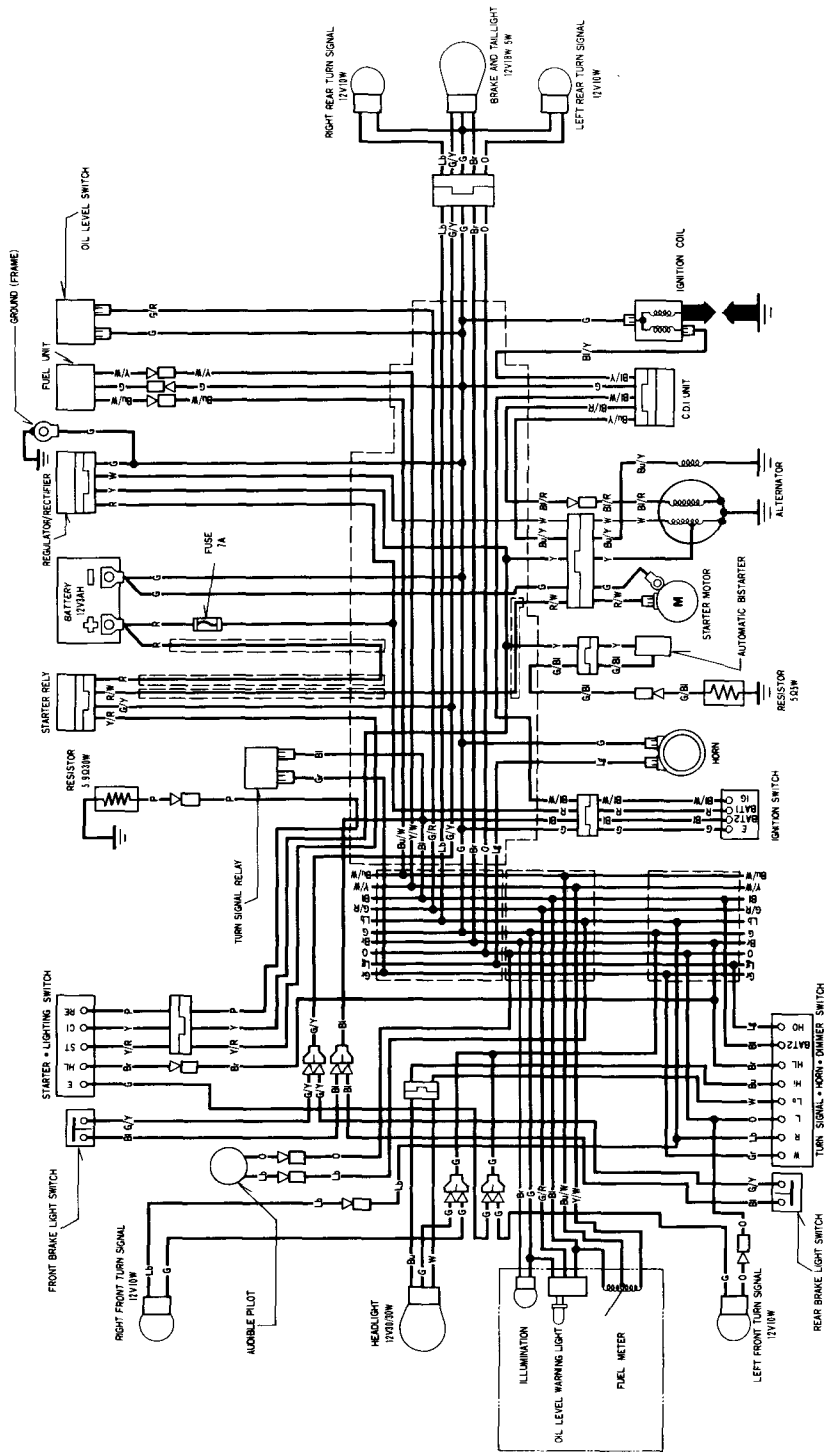

- B BLACK
- Y YELLOW
- B BLUE
- G GREEN
- R RED
- W WHITE
- P BROWN
- O ORANGE
- L3 LIGHT BLUE
- L4 LIGHT GREEN
- P PINK
- G GRAY

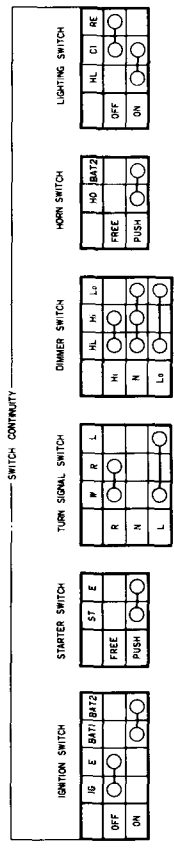

0030Z--GR1--6500