

**Dio SR**

**SK50M OWNER'S MANUAL**

## IMPORTANT NOTICE

### **OPERATOR ONLY. NO PASSENGER**

- This scooter is designed and constructed as an operator-only model. The seating configuration does not safely permit the carrying of a passenger. Do not exceed the maximum weight capacity shown on the accessories and loading label.

### **ON-ROAD USE ONLY**

This scooter is not equipped with a spark arrester and is designed to be used only on the road. Operation in forest, brush or grass covered areas may be illegal. Obey local laws and regulations.

### **READ THIS OWNER'S MANUAL CAREFULLY**

- Pay special attention to statements preceded by the following words:

#### **▲ WARNING**

**Indicates a strong possibility of severe personal injury or death if instructions are not followed.**

#### **CAUTION:**

**Indicates a possibility of personal injury or equipment damage if instructions are not followed.**

#### **NOTE:**

Gives helpful information.

This manual should be considered a permanent part of the scooter and should remain with the scooter when resold.

**HONDA SK50M**  
**Dio SR**  
**OWNER'S MANUAL**

**1996**

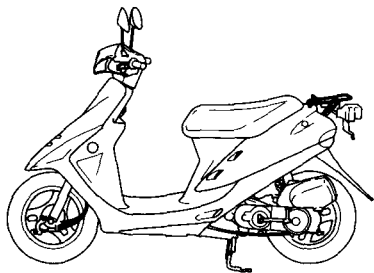

**All information in this publication is based on the latest production information available at the time of approval for printing. HONDA MOTOR CO., LTD. reserves the right to make changes at any time without notice and without incurring any obligation.**

**No part of this publication may be reproduced without written permission.**

© Honda Motor Co., Ltd., 1995

## WELCOME

Thank you for purchasing this Honda scooter, and welcome to the family of Honda scooter riders. To enjoy safer and more pleasant riding, become thoroughly familiar with this owner's manual **BEFORE YOU RIDE THE SCOOTER**. Your safety depends not only on your own alertness and familiarity with the scooter, but also the scooter's mechanical condition. A pre-ride inspection before every outing and regular maintenance are essential.

When regular maintenance or repairs are required, remember that your authorized Honda scooter dealer knows what it takes to keep your Honda going strong. If you have the required mechanical "know-how" and tools, your Honda dealer can supply you with an official Honda Service Manual to help you perform many maintenance and repair tasks.

Pleasant riding, and thank you for choosing a Honda.

- The illustrations and photos herein are based on the CM type.
- Following codes in this manual indicate each country.

CM	Canada
U	Australia

- The specifications may vary with each locale.

# **OPERATION**

Page

- 1 SCOOTER SAFETY
- 3 Safe riding Rules
- 5 Modifications
- 6 Protective Apparel
- 7 Loading and Accessories
  
- 10 PARTS LOCATION
- 13 Parts Function
  
- 17 MAJOR COMPONENTS (Information you need to operate this scooter)
- 17 Brakes
- 20 Fuel
- 23 Engine Oil
- 25 Tires
  
- 28 ESSENTIAL INDIVIDUAL COMPONENTS
- 28 Ignition Switch
- 29 Right Handlebar Controls
- 30 Left Handlebar Controls

Page

- 31 FEATURES (Not required for operation)
- 31 Steering Lock
- 31 Seat Lock
- 32 Helmet Holder
- 33 Center Compartment
- 34 Hook and Inner Rack
  
- 35 OPERATION
- 35 Pre-ride Inspection
- 36 Starting the Engine
- 41 Break-in
- 42 Riding
- 49 Parking
- 50 Anti-theft Tips

# **MAINTENANCE**

Page

- 51 MAINTENANCE
- 52 Maintenance Schedule
- 56 Maintenance Record
- 57 Serial Numbers
- 58 Color Label
- 59 Maintenance Precautions
  
- 60 FILTERS/LUBRICATION
- 60 Air Cleaner
  
- 62 ENGINE
- 62 Spark Plug
- 64 Idle Speed
  
- 65 FRAME/BRAKES
- 65 Brake shoe wear

Page

- 66 ELECTRICAL
- 66 Battery
- 67 Fuse Replacement
  
- 69 TRANSPORTING
  
- 70 CLEANING
  
- 72 STORAGE GUIDE
- 72 Storage
- 73 Removal from storage
  
- 74 SPECIFICATIONS
  
- 77 NOISE CONTROL SYSTEM  
(AUSTRALIA ONLY)

# SCOOTER SAFETY

Read these WARNING LABELS before you ride.

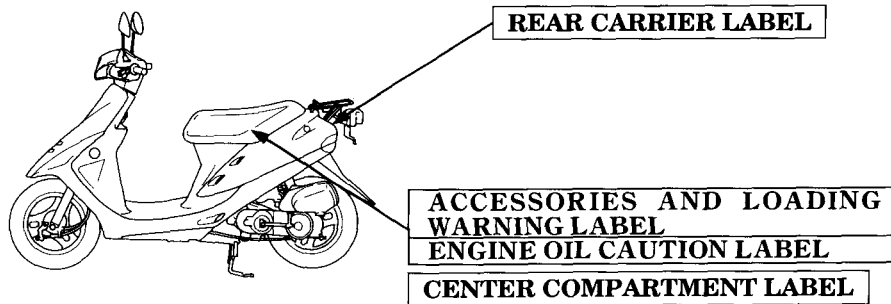

**S  
C  
O  
O  
T  
E  
R  
  
S  
A  
F  
E  
T  
Y**

**OPERATOR WARNING LABEL**

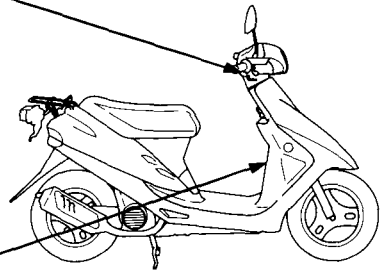

**TIRE INFORMATION LABEL**

**▲ WARNING**

**\* Scooter riding requires special efforts on your part to ensure your safety. Know these requirements before you ride:**

**SAFE RIDING RULES**

1. Always make a pre-ride inspection (page 35) and perform any needed adjustments or repairs before you ride the scooter. You may prevent an accident or equipment damage.

2. This scooter has been designed and constructed as an operator-only model. There are no provisions for carrying passengers safely. Vehicle stability and control may be severely affected. Never carry passengers.

**NO PASSENGERS**

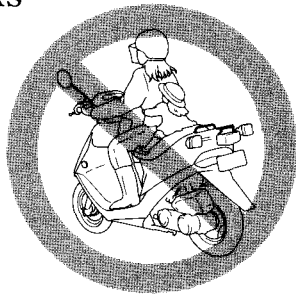
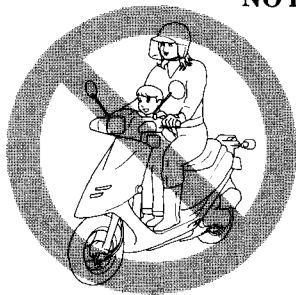

3. Many accidents involve inexperienced riders. Most states require a special riding test or license. Make sure you are qualified before you ride. NEVER lend your scooter to an inexperienced rider.
4. Many automobile/scooter accidents happen because the automobile driver does not "see" the rider. Make yourself conspicuous to help avoid the accident that wasn't your fault:
  - Wear bright or reflective clothing.
  - Don't ride in another motorist's "blind spot."
5. Obey all federal, state and local laws and regulations.
  - Excessive speed is a factor in many accidents. Obey the speed limits, and NEVER travel faster than conditions warrant.
  - Signal before you make a turn or lane change to alert other motorists of your intentions.
6. Don't let other motorists surprise you. Use extra caution at intersections, parking lot entrances and exits, and driveways.
7. This scooter is designed for speeds up to 38 mph. Check local and state laws limiting operation. Riding on roads where other vehicles are traveling at greater rates of speed is not advisable. If you must ride in these conditions, be especially alert.
8. Keep both hands on the handlebars and both feet on the floor boards while riding.
9. Never leave your scooter unattended with the engine running.

10. Moderate your speed when riding over bumpy roads. Avoid hitting road hazards, such as sharp bumps and holes, in the road surface. These hazards can cause loss of control or structural damage to the vehicle.

## MODIFICATIONS

### **▲ WARNING**

- \* **Modification of the scooter or removal of original equipment may render the vehicle unsafe or illegal. Obey all federal, state and local equipment regulations.**

## PROTECTIVE APPAREL

S  
C  
O  
O  
T  
E  
R  
  
S  
A  
F  
E  
T  
Y

ALWAYS wear a helmet.

You should also wear a face shield or goggles.

Clothes should be close-fitting.

Wear bright or reflective clothing.

Wear gloves.

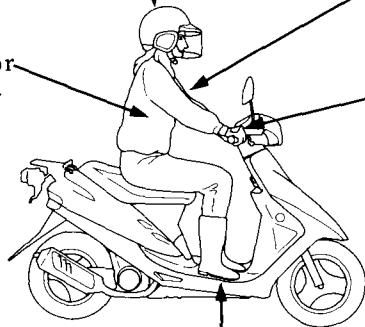

Shoes should be close-fitting, have low heels and offer ankle protection.

## LOADING AND ACCESSORIES

### ▲ WARNING

**\* A scooter is sensitive to changes in weight distribution. Improper loading of cargo and mounting of accessories can impair the scooter's stability and performance. To prevent an accident, use extreme care when mounting accessories and riding with cargo.**

These general guidelines may help you decide whether or how to equip your scooter, and how to load it safely.

1. The combined weight of the rider, cargo, and all accessories must not exceed the maximum weight capacity: 91 kg (200 lbs)
2. Do not install another fairing or modify the existing one.
3. Do not carry items that protrude through the rack or block the taillight.
4. Do not carry pets on either carrier.

5. Keep cargo weight low and close to the center of the scooter. As weight is located farther from the center of gravity, handling is proportionally affected. Load weight equally to minimize imbalance.
6. When the optional front basket is installed, be sure that loaded parcels do not protrude from the basket, since the parcels may interfere with the steering or headlight.

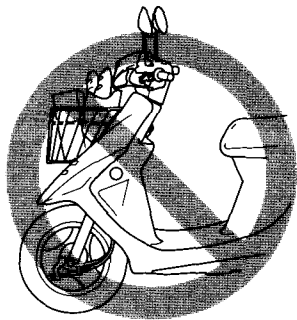

## Overloading the scooter will adversely affect stability and handling.

Be sure all cargo is secure before riding.

Rear carrier:  
never exceed the maximum  
weight limit:  
3 kg (6.6 lbs)

Center compartment:  
never exceed the maximum  
weight limit:  
10 kg (22 lbs)

Hook and Inner Rack:  
never exceed the maximum weight  
limit:  
1.5 kg (3 lbs)

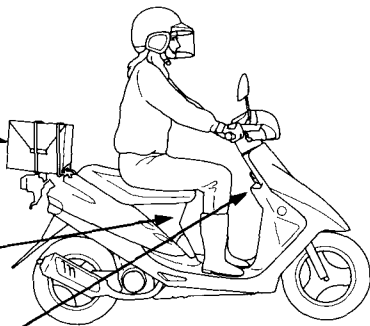

# PARTS LOCATION

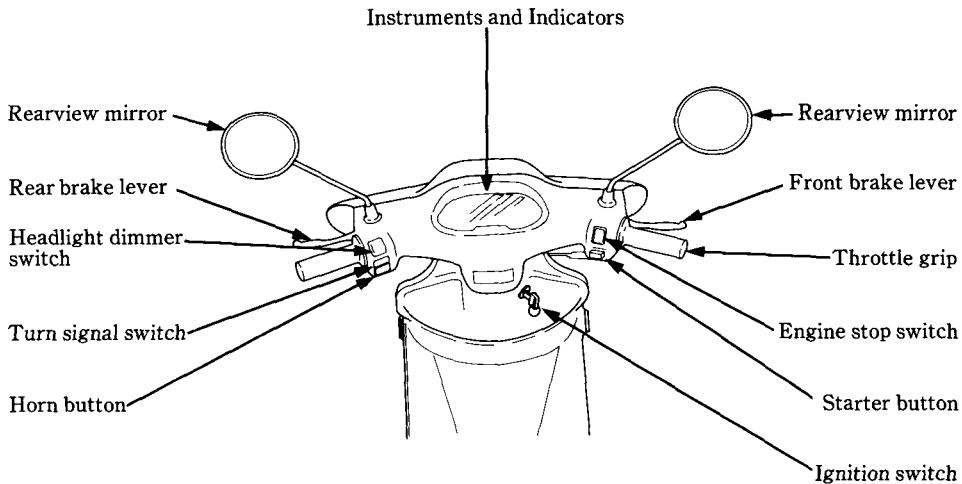

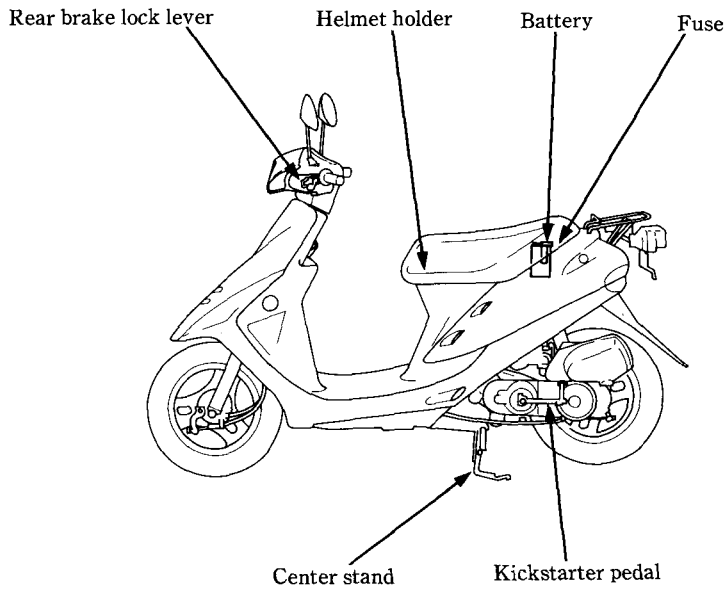

Engine oil tank cap

Hook

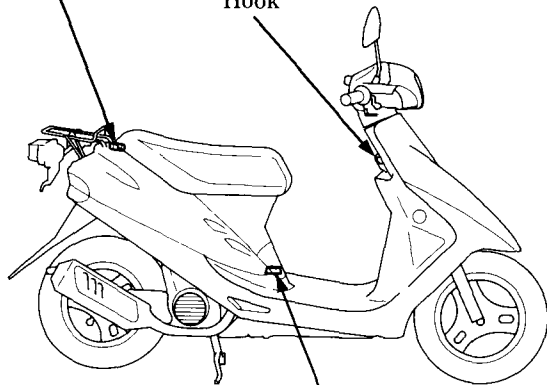

Fuel fill cap

## PARTS FUNCTION

### Instruments and Indicators

The indicators are grouped between the handlebars.

Their functions are described in the table on the following page.

- (1) Speedometer
- (2) Fuel gauge
- (3) Low oil level indicator
- (4) High beam indicator
- (5) Odometer
- (6) Turn signal indicator

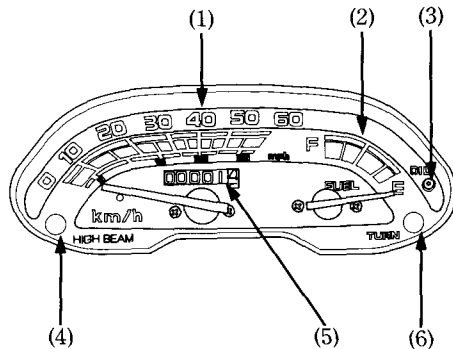

<b>(Ref. No.) Description</b>	<b>Function</b>
(1) Speedometer	Shows riding speed.
(2) Fuel gauge	Shows approximate fuel supply available (see page 15).
(3) Low oil level indicator (red)	Lights when oil level is low (see page 16).
(4) High beam indicator	Lights when the headlight is on high beam.
(5) Odometer	Shows accumulated mileage.
(6) Turn signal indicator	Flashes when either turn signal is operated.

## Fuel Gauge

The fuel gauge (1) shows the approximate fuel supply available. At F (Full), the fuel tank capacity including reserve is:

5.0 l (1.32 US gal, 1.10 Imp gal)

When the gauge needle enters the red band (2), fuel will be low and you should refill the tank as soon as possible. The amount of fuel left in the tank when the needle enters the red band is approximately:

1.2 l (0.32 US gal, 0.26 Imp gal)

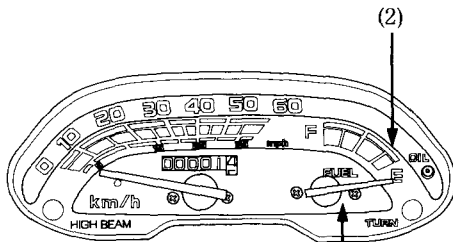

(1) Fuel gauge (2) Red band (1)

## Low Oil Level Indicator

The low oil level indicator (1) lights when the 2-stroke engine oil level is below approximately:

0.2 l (0.2 US qt, 0.2 Imp qt)

### **▲ WARNING**

- \* If the low oil level indicator comes on while riding, stop riding and shut the engine off. Fill the oil tank to the UPPER LEVEL mark with the recommended oil (see page 24). Continuing to ride with a low oil level may lead to engine failure that could result in an accident.

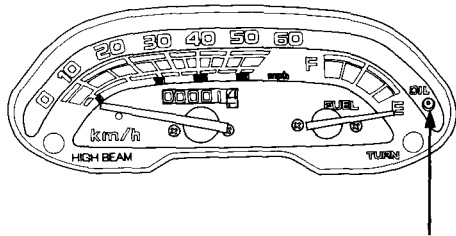

(1) Low oil level indicator

## MAJOR COMPONENTS (Information you need to operate this scooter)

### ▲WARNING

- \* If the Pre-ride Inspection (page 35) is not performed, severe personal injury or vehicle damage may result.

## BRAKES

### Adjustment

1. Measure the distance the front brake lever (1) and the rear brake lever (2) move before each brake starts to take hold. Free play at the tips of the brake levers should be:  
10–20 mm

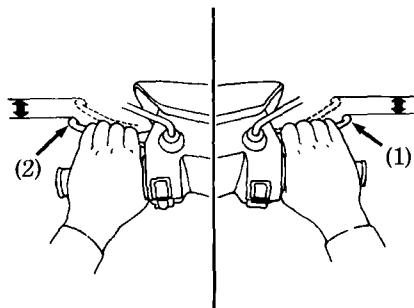

- (1) Front brake lever
- (2) Rear brake lever

2. Make free play adjustments by turning the adjusting nut (3) at the brake arm.

**Front**

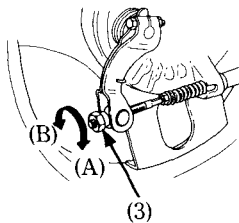

**Rear**

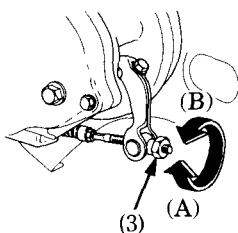

(3) Adjusting nut

(A) Decrease free play

(B) Increase free play

Make sure the cut-out on the adjusting nut is seated on the brake arm pin (4) after making final free play adjustment.

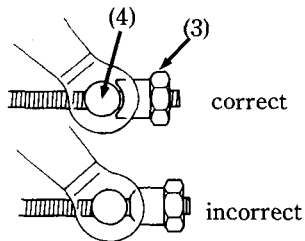

(3) Adjusting nut (4) Arm pin

3. Apply each brake several times and check for free wheel rotation after the brake lever is released.

**NOTE:**

- \* If proper adjustment cannot be obtained by this method, see your authorized Honda scooter dealer.

**Other Checks**

Check the brake cable for kinks or signs of wear that could cause sticking or failure.

Lubricate the brake cable with a commercially available cable lubricant to prevent premature wear and corrosion.

Make sure the brake arm, spring and fasteners are in good condition.

## FUEL

### Fuel Tank

The fuel tank is located under the step board. Unlock and open the fuel tank lid (1) with the ignition key, then remove the fuel fill cap (2) by turning it counterclockwise. Fuel tank capacity is:

5.0 l (1.32 US gal, 1.10 Imp gal)

Install the fuel fill cap by turning it clockwise. Make sure to lock the fuel tank lid securely after filling.

Your engine is designed to use any gasoline that has a pump octane number of 86 or higher. Gasoline pumps at service stations normally display the pump octane number.

We recommend that you use unleaded fuel because it produces fewer engine and spark plug deposits and extends the life of exhaust system components.

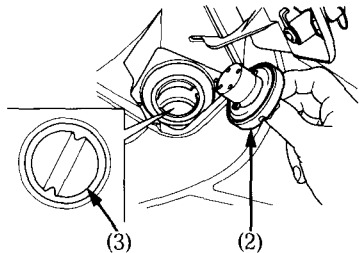
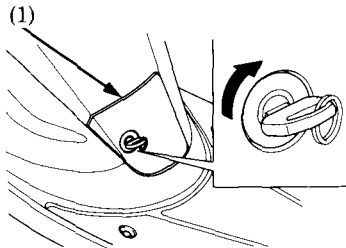

(1) Fuel tank lid (2) Fuel fill cap (3) Filler neck

Never use stale or contaminated gasoline or an oil/gasoline mixture. Avoid getting dirt, dust or water in the fuel tank. Use of a lower octane gasoline can cause persistent “pinging” or heavy “spark knock” (a metallic rapping noise) which, if severe, can lead to engine damage.

**FOR AUSTRALIA ONLY:**

Use unleaded petrol with a research octane number of 91 or higher.

**CAUTION:**

- \* If “spark knock” or “pinging” occurs at a steady engine speed under normal load, change brands of gasoline. If spark knock or pinging persists, consult your authorized Honda dealer. Failure to do so is considered misuse, and damage caused by misuse is not covered by Honda’s Limited Warranty.

Occasionally you may experience light spark knock while operating under heavy loads. This is no cause for concern, it simply means your engine is operating efficiently.

**▲ WARNING**

- \* Gasoline is extremely flammable and is explosive under certain conditions. Refuel in a well-ventilated area with the engine stopped. Do not smoke or allow flames or sparks in the area where gasoline is stored or where the fuel tank is refueled.
- \* Do not overfill the tank (there should be no fuel in the filler neck (3). After refueling, make sure the fuel fill cap is closed securely.
- \* Be careful not to spill fuel when refueling. Spilled fuel or fuel vapor may ignite. If any fuel is spilled, make sure the area is dry before starting the engine.
- \* Avoid repeated or prolonged contact with skin or breathing of vapor. **KEEP OUT OF REACH OF CHILDREN.**

## Oxygenated Fuels

Some conventional gasolines are being blended with alcohol or an ether compound. These gasolines are collectively referred to as oxygenated fuels. To meet clean air standards, some areas of the United States and Canada use oxygenated fuels to help reduce emissions.

If you use an oxygenated fuel, be sure it is unleaded and meets the minimum octane rating requirement.

Before using an oxygenated fuel, try to confirm the fuel's contents. Some states/provinces require this information to be posted on the pump.

The following are the EPA approved percentages of oxygenates:

**ETHANOL** (ethyl or grain alcohol) 10% by Volume

You may use gasoline containing up to 10% ethanol by volume. Gasoline containing ethanol may be marketed under the name "Gasohol".

**MTBE** (Methyl Tertiary Butyl Ether) 15% by Volume

You may use gasoline containing up to 15% MTBE by volume.

**METHANOL** (methyl or wood alcohol) 5% by Volume

You may use gasoline containing up to 5% methanol by volume as long as it also contains cosolvents and corrosion inhibitors to protect the fuel system. Gasoline containing more than 5% methanol by volume may cause starting and/or performance problems. It may also damage metal, rubber, and plastic parts of your fuel system.

If you notice any undesirable operating symptoms, try another service station or switch to another brand of gasoline.

Fuel system damage or performance problems resulting from the use of an oxygenated fuel containing more than the percentages of oxygenates mentioned above are not covered under warranty.

## ENGINE OIL Oil Level

When the low oil level indicator lights, it means the oil level in the oil tank is low; stop the engine and fill the oil tank as soon as possible.

### **▲ WARNING**

- \* If the low oil level indicator comes on while riding, stop riding and shut the engine off. Fill the oil tank to the UPPER LEVEL mark with the recommended oil (see page 24). Continuing to ride with a low oil level may lead to engine failure that could result in an accident.

### **CAUTION:**

- \* If the engine has been run after the oil indicator light has come on, the scooter must be taken to an authorized Honda scooter dealer for inspection and bleeding of the oil system. Failure to do this will result in serious engine damage.

To fill, lift the seat, lift the oil tank lid (1), (2) remove the cap (3) from the oil tank, and fill with the recommended oil up to the UPPER LEVEL mark (4).

### **Capacity:**

1.2 ℓ (1.2 US qt, 1.0 Imp qt)

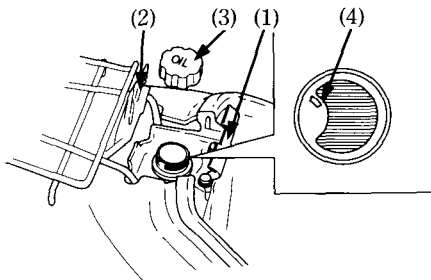

- (1), (2) Oil tank lid  
(3) Oil tank cap (4) UPPER LEVEL mark

**Oil Recommendation:**

USE HONDA 2-STROKE OIL OR AN EQUIVALENT

**CAUTION:**

- \* **The use of improper oils may cause excessive and/or premature carbon build-up in the engine and exhaust system, resulting in loss of power and possible engine damage. Genuine Honda 2-Stroke Oil has been specifically designed and tested in Honda scooters and is a proper oil.**

**NOTE:**

- \* When filling, do not let dirt or other foreign materials enter the tank.